

BATHROOM

ideas™



**HEALTHCARE,
ACCESSIBLE AND
COMMERCIAL SPACES**





SPECIFICATION

Bathroom ideas are at the heart of what we do here at Robertson. Our Consultants to Architects and Designers are constantly striving to give sound advice and guidance throughout the specification process; from early planning through the tendering phases, installation stage and post project maintenance.

SCHEDULE & EARLY PLANNING

An individual product schedule provided with all essential information including product breakdown, codes, dimensional drawings and features. A customised presentation allows your project to come to life, visualising different finishes, textures and designs all in one place.

ESTIMATES & PRICING

We will endeavour to provide a cost effective solution suitable to the projects' needs and work tirelessly with our international suppliers to ensure projects are priced accordingly.

AFTER SALES SERVICE

We have an extensive range of spare parts for all Robertson products. Whether it's replacement parts for a repair job or optional extras to add new functionality. Coupled with our expert After Sales Service team on hand to offer advice and technical information well after the project is completed.

SUSTAINABILITY

At Robertson Bathware we care deeply about the planet and about safeguarding our precious natural resources. While we strive to create beautiful, high-quality bathroom products, we also take our responsibility to protecting our environment very seriously.

That's why we pledge an ongoing commitment to limit the impact of our activities on the environment, and to provide a safe and healthy workplace for our employees.

Our goal is to integrate sustainable practices into every aspect of our operations, from the design and development of our products, to their production, packaging and distribution.

We also educate our employees about sustainable practices they can implement, and seek to work with suppliers and partners who share our environmentally responsible values.

BORN FROM A MIX OF GLOBAL EXPERIENCE AND LOCAL KNOWLEDGE

Our diverse portfolio covers an impressive number of prestigious projects within New Zealand and across the Asia Pacific region.

Notable specifications:

Te Arikiniui Pullman Auckland Airport – Tapware and Mixers / Showers / Basins / Baths / Toilets / Accessories

Sofitel So Auckland – Tapware and Mixers / Showers / Baths

The Westin Denarau Island – Tapware and Mixers / Showers

Six Senses Fiji – Tapware and Mixers / Showers

The Roki Hotel Queenstown – Tapware and Mixers / Showers / Baths

Cordis Hotel Pinnacle Tower Auckland – Tapware and Mixers / Showers / Baths / Accessories

Marriott Resort Momi Bay – Tapware / Basins / Baths / Accessories

The Horizon Hotel Auckland – Tapware and Mixers / Showers / Baths

Mayfair Hotel Christchurch – Tapware and Mixers

Holiday Inn Express Queenstown – Tapware and Mixers / Basins / Toilets

Crowne Plaza Christchurch & Fiji – Tapware and Mixers / Toilets / Accessories

CORDIS
HOTELS & RESORTS
AUCKLAND

R
RYDGES

H
Hilton

hoteldebrett

C
CROWNE PLAZA

SOFITEL
LUXURY HOTELS

HOTEL S/MORITZ

G
GRAND PAPUA
HOTEL

H
Holiday Inn

SIX SENSES
HOTEL

KINLOCH
CLUB

M
MARRIOTT

S
Sheraton

I
INTERCONTINENTAL

H
HOTEL GRAND WINDSOR

MATAKAURI
HOTELS & RESORTS

SO
SOFITEL

PULLMAN
HOTELS AND RESORTS

Q
QUEST
HOTELS

SUDIMA
HOTELS

OUR PROJECT PORTFOLIO



AUCKLAND HOSPITAL
AUCKLAND, NEW ZEALAND



ALPERS DENTAL
AUCKLAND, NEW ZEALAND



TRIVET RESTAURANT | JW MARRIOTT
AUCKLAND, NEW ZEALAND



THE ANCHORAGE
WHANGAREI, NEW ZEALAND



KENSINGTON PARK
OREWA, NEW ZEALAND



HUAPAI COUNTRY CLUB
HUAPAI, NEW ZEALAND



FAIRVIEW VILLAGE
AUCKLAND, NEW ZEALAND



ST ANDREWS VILLAGE
AUCKLAND, NEW ZEALAND



METLIFECARE RETIREMENT VILLAGE
AUCKLAND, NEW ZEALAND



POYNTON
AUCKLAND, NEW ZEALAND



THE FOUNDATION
AUCKLAND, NEW ZEALAND



PACIFIC COAST VILLAGE
TAURANGA, NEW ZEALAND



THE VINES AT BETHLEHEM
TAURANGA, NEW ZEALAND



COPPER CREST
TAURANGA, NEW ZEALAND



BUPA RETIREMENT VILLAGES
NAPIER, TOTARA, CROFTON DOWNS,
PALMERSTON NORTH, ASHFIELD



RUSSELY VILLAGE
CHRISTCHURCH, NEW ZEALAND



PALM GROVE
CHRISTCHURCH, NEW ZEALAND



RANFURLY VILLAGE
CHRISTCHURCH, NEW ZEALAND

BASINS

ALICE HIDE 500 WALL BASIN

500(L) X 350(W) X 135(H)
1TH / NO OVERFLOW
VITREOUS CHINA:
312701__S



ALICE SPY 400 WALL BASIN

400(L) X 300(W) X 110(H)
1TH / NO OVERFLOW
VITREOUS CHINA:
341201__



DESIGNED BY MASSIMILIANO BRACONI

The essence of Italian minimalism by Alice Ceramica Art Director and Designer Massimiliano Braconi.

Spy is a collection of washbasins specially designed for saving space, practicality, and comfort. A great statement piece to neatly fit any modern bathroom.

HIDE/SPY FINISHES

Select finish code below e.g. Spy 400 Wall Basin with Matt Sand finish: 341201**44**



FLAMINIA APP LIGHT 500 WALL BASIN

500(L) X 370(W) X 140(H)
NTH OR 1TH / WITH OVERFLOW
VITREOUS CHINA

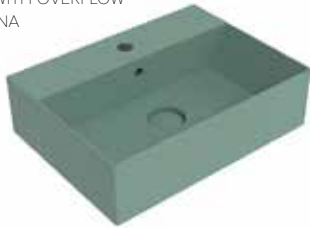

GLOSS WHITE:
NTH:
FLAP5037__
1TH:
FLAP5037-1__

FLAMINIA APP LIGHT 600 WALL BASIN

600(L) X 370(W) X 140(H)
NTH OR 1TH / WITH OVERFLOW
VITREOUS CHINA



GLOSS WHITE:
NTH:
FLAP6037__
1TH:
FLAP6037-1__

WITH OR WITHOUT TAP HOLE?

App Light gives you the choice of either a No Tap Hole or Single Tap Hole basin giving you flexibility of tapware whether it be deck or wall mounted.

APP LIGHT FINISHES

Select finish code below e.g. App Light 500 Wall/Vessel 1TH Basin with Menta finish: FLAP5037-1**ME**

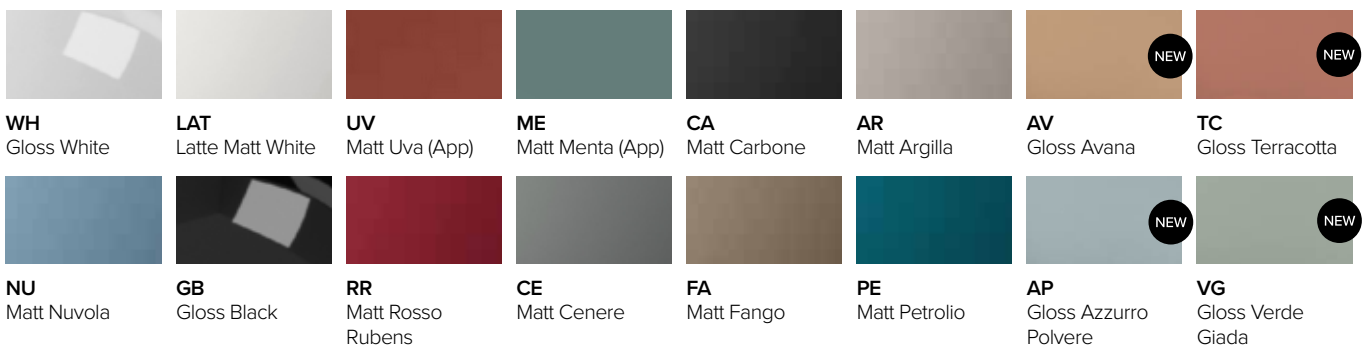

alice

10 year Residential & Commercial Guarantee*
Hand Finished Vitreous China

Designed by Massimiliano Braconi
Made in Italy

→FLAMINIA.

10 year Residential & Commercial Guarantee*
Hand Finished Vitreous China

Made in Italy

To meet NZS 4121:2001 compliance, please include Insulated Bottle Trap

Hide 500 Wall Basin
Finish: Matt Rose
Hansa Electra Sensor Basin Mixer
Finish: Chrome



BASINS

PARISI
LINFA 400 WALL BASIN
 400(L) X 380(W) X 120(H)
 WITH OVERFLOW
 VITREOUS CHINA
 NTH / GLOSS WHITE:
PMP7700S
 1TH / GLOSS WHITE:
PMP7701S



PARISI
LINFA 550 WALL BASIN
 550(L) X 380(W) X 125(H)
 1TH / WITH OVERFLOW
 VITREOUS CHINA
 NTH / GLOSS WHITE:
PMP7600S
 1TH / GLOSS WHITE:
PMP7601S



COTTO
SERVE S WALL BASIN
 500(L) X 375(W) X 175(H)
 1TH / WITH OVERFLOW
 VITREOUS CHINA
 GLOSS WHITE:
C00580



COTTO
SEMI PEDESTAL
 COMPATIBLE WITH
 SERVE S WALL BASIN
 VITREOUS CHINA
 GLOSS WHITE:
C4243



Note:
 Please check your
 local regulations
 whether a semi
 pedestal is required
 for accessible
 applications.

COTTO
WENDY WALL BASIN
 550(L) X 440(W) X 200(H)
 1TH / WITH OVERFLOW
 VITREOUS CHINA
 GLOSS WHITE:
C014



NEW

NTH / WITH OVERFLOW
 VITREOUS CHINA
 GLOSS WHITE:
C014NTH



COTTO
FULL PEDESTAL
 COMPATIBLE WITH
 WENDY WALL BASIN
 VITREOUS CHINA
 GLOSS WHITE:
C411



COTTO
FLOAT 425 WALL BASIN

NEW

GLOSS WHITE:
C00667



MATT BLACK:
C0066.MBK



COTTO
FLOAT 625 WALL BASIN

NEW

GLOSS WHITE:
C00687



MATT BLACK:
C0068.MBK



FINISHES

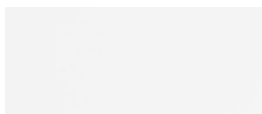

Gloss White



MBK
 Matt Black

ADVANCED CLAY TECHNOLOGY

CottoCeram™ advanced clay technology provides a durable, anti-crazing finish.

PARISI

COTTO

10 Year Residential Guarantee*
 5 Year Commercial Guarantee*

10 Year Residential Guarantee*
 5 Year Commercial Guarantee*

UltraClean+
 CottoCeram™

To meet NZS 4121:2001
 compliance, please include
 Insulated Bottle Trap



Serve S Wall Basin with Semi Pedestal
Savon Basin Mixer with Lab Lever Handle



WASTES

ELEMENTI
UNIVERSAL
BASIN CLICKER
WASTE 32MM

79230.__



ELEMENTI FINISHES

Select finish code below e.g. Elementi Basin Clicker Waste with Ceramic Black finish: 79230.**13**

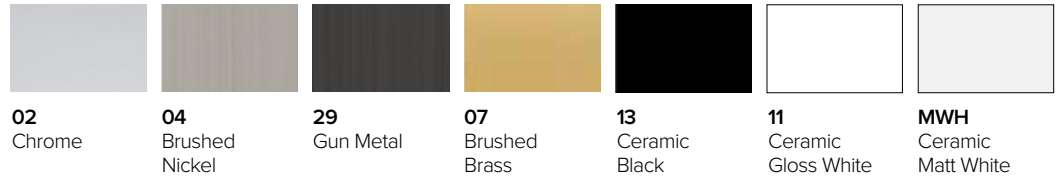

FLAMINIA
BASIN CLICKER
WASTE 32MM
OVERFLOW/NO OVERFLOW
FLPLCE.__



FLAMINIA
BASIN CLICKER
WASTE 32MM
OVERFLOW/NO OVERFLOW
CHROME ONLY
FLPLSG.CP



THE FINAL TOUCH

Add that final touch by matching your waste with your basin finish. Both Flaminia and Alice offer colour wastes in an array of finishes allowing you to go for a cohesive look.

FLAMINIA FINISHES

Select finish code below e.g. Flaminia Basin Clicker Waste with Nuvola finish: FLPLCE.**NU**

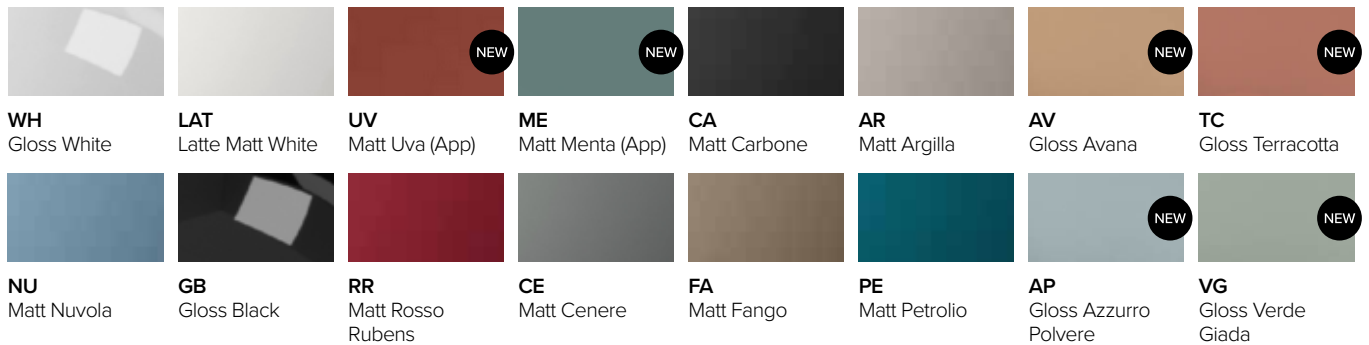

ALICE
BASIN CLICKER WASTE 32MM
NO OVERFLOW
NOT COMPATIBLE WITH EQUILIBRIUM 351001__ VESSEL BASIN UNLESS INSTALLED ON EQUILIBRIUM PEDESTAL
PIL008__

OPTIONAL EXTRA:
EXTENSION FOR FIXING TO PEDESTAL REQUIRED FOR EQUILIBRIUM 351001__ VESSEL BASIN WHEN INSTALLED ON EQUILIBRIUM PEDESTAL
MPROCL



ALICE
EXTENDED BASIN
CLICKER WASTE 32MM
NO OVERFLOW COMPATIBLE WITH EQUILIBRIUM 351001__ VESSEL BASIN WHEN BEING INSTALLED ON COUNTERTOP
PIL010__



ALICE FINISHES

Select finish code below e.g. Alice Basin Clicker Waste with Matt White finish: PIL008**09**



BOTTLE TRAPS

ELEMENTI
**32MM INSULATED
 BOTTLE TRAP**

CHROME:
79144.02

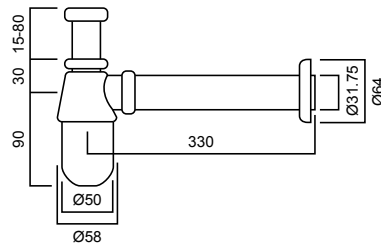

INSULATED BOTTLE TRAP

A separate internal sleeve prevents accidental scalding by keeping hot water away from the exterior. Using an insulated bottle trap can eliminate the need for a semi pedestal/cover for accessible compliant bathrooms.

ELEMENTI
UNIVERSAL 32MM BOTTLE TRAP

CHROME:
79104.02



BRUSHED NICKEL:
79104.04



GUN METAL:
79104.29



BLACK:
79104.13



WHITE:
79104.10



ELEMENTI
**UNIVERSAL BOTTLE TRAP
 EXTENSION**

VERTICAL 200MM
 CHROME:
TP32-200



VERTICAL 200MM
 BRUSHED NICKEL:
TP32-200-BN



VERTICAL 200MM
 GUN METAL:
TP32-200-GM



VERTICAL 200MM
 BLACK:
TP32-200-B



VERTICAL 200MM
 WHITE:
TP32-200-W



HORIZONTAL 600MM
 CHROME:
TP32-600



HORIZONTAL 600MM
 BRUSHED NICKEL:
TP32-600-BN



HORIZONTAL 600MM
 GUN METAL:
TP32-600-GM



HORIZONTAL 600MM
 BLACK:
TP32-600-B



HORIZONTAL 600MM
 WHITE:
TP32-600-W



EXTENDABLE BOTTLE TRAP

Vertical (200mm) and horizontal (600mm) bottle trap extensions for the Elementi Universal trap are available in 5 finishes. These extensions can be simply cut down to whatever length is required.

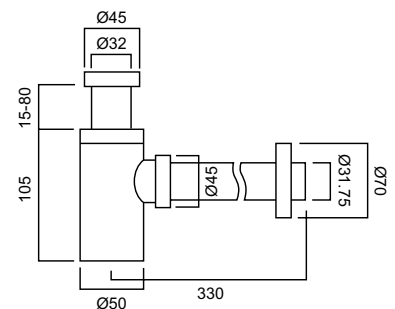

RIMLESS OVERHEIGHT, AGE CARE AND ACCESSIBLE BACK TO WALL TOILETS

**ELEMENTI
UNO OVERHEIGHT
BTW CC TOILET SUITE**

RIMLESS HYPER JET FLUSH
SET OUTS:
S PAN: 55-132MM
178-215MM WITH
OPTIONAL 12607.00 BEND
P PAN: 180MM
WELS 4 STAR:
4.5 L PER FULL FLUSH
3 L PER HALF FLUSH
BOTTOM LEFT, BOTTOM RIGHT
& BACK INLET
GLOSS WHITE
VITREOUS CHINA

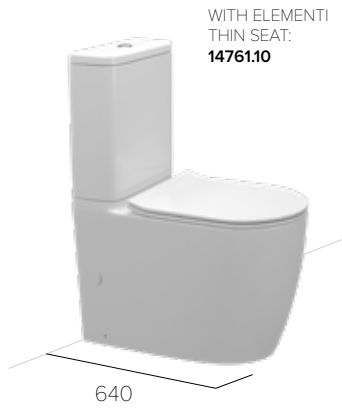

****Does not comply** with NZS 4121:2001

**ELEMENTI
UNO AGE CARE/OVERHEIGHT
BTW CC TOILET SUITE**

RIMLESS HYPER JET FLUSH
WELS 4 STAR:
4.5 L PER FULL FLUSH
3 L PER HALF FLUSH
BOTTOM LEFT, BOTTOM RIGHT
& BACK INLET
SET OUTS:
S PAN: 150-297
55-200MM WITH OPTIONAL
15020.10 BEND
P PAN: 180
GLOSS WHITE
VITREOUS CHINA



****Does not comply** with NZS 4121:2001



DESIGNED FOR ACCESSIBILITY

The Uno Accessible/Overheight is also available with a raised push button and coloured seat for those with visual impairment. View robertson.co.nz for more information.



Does comply with NZS 4121:2001

ELEMENTi®

PARISI

10 Year Guarantee*
Hand Finished Vitreous China
E-Glaze Technology

E-Guard Technology
Hyper Jet Flushing System
Hygienic Rimless Design

Complies with NZS 4121:2001
(Uno Accessible/Overheight)
Soft Close Seat System (Does not apply to
14859.10 / 14858.10 / 14890.10 / 14892.10)

10 Year Guarantee
(Sway D2 Seat)*

Uno Overheight/Accessible BTW CC Toilet Suite
 Blue Accessible Seat and Raised Push Button
 Support 90 Degree Grab Rail

Serve S Wall Basin with Semi Pedestal
 Savon Basin Mixer with Lab Lever Handle



BLURRED?

A contrasting blue toilet seat and raised push button are perfect for those living with dementia or with restricted vision. The dark blue seat and button stand out amongst the environment to make life easier for those in need.

MAKE LIFE A LITTLE EASIER

With a pan and seat up to 40mm higher than standard toilets, the overheight toilet allows for easy transfer on and off the seat. This not only makes life easier as we increase in age, but is ideal for the elderly and those with restricted movement.

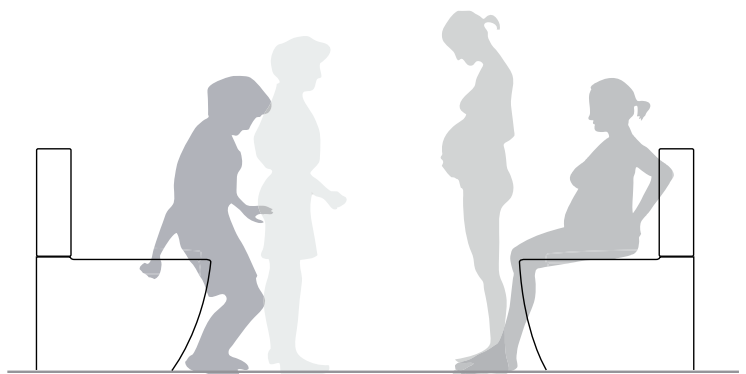

Fresca E-Bidet Features:

10 Year Guarantee*
 2 Year Guarantee on Seat*
 1 Year Guarantee on Cistern Parts
 & Electrical Components*

E-Glaze Technology
 Hyper Jet Flushing System
 Adjustable Water
 Temperature & Volume

Adjustable Heated Seat
 Seat Night Light
 Soft Close
 Antibacterial Seat

*All guarantees are subject to terms
 and conditions and available at:
robertson.co.nz/warranties



ACCESSIBLE TOILETS

ELEMENTI

**UNO OVERHEIGHT/ACCESSIBLE
BACK TO WALL TOILET PAN**

RIMLESS HYPER JET FLUSH

SET OUTS:

S PAN: 310MM

P PAN: 180MM

WELS 4 STAR:

4.5 L PER FULL FLUSH

3 L PER HALF FLUSH

GLOSS WHITE

VITREOUS CHINA



WITH ELEMENTI
THIN SEAT:
14870.10



WITH ELEMENTI
THICK SEAT:
14871.10



WITH PARISI
SWAY D2 SEAT:
14872.10



WITH ELEMENTI
BLUE ACCESSIBLE
SEAT:
14878.10



WITH ELEMENTI
WHITE ACCESSIBLE
SEAT:
14876.10



WITH ELEMENTI
FRESCA SEAT:
14870-BD.10



Does comply with NZS 4121:2001

PARISI

**TWIN BUTTON RAISED ACCESSIBLE
PNEUMATIC PLATE**

CHROME:
PA261.02



BRUSHED NICKEL:
PA262.04



PARISI

**PNEUMATIC 90MM
INWALL CISTERN**

FRONT FLUSH

NO FRAME

FOR BTW PANS

REQUIRES PUSH PLATE

WELS 4 STAR

CODE:

PA111



RAISED BUTTONS

The Accessible Twin Button Push Plate includes raised buttons extending 25mm for ease of use coupled with embossed domes for those with visual impairment.

When using the pneumatic option and installing the inwall cistern into a 90mm cavity:

- The cistern can be reversed so the maintenance panel can be in a different room or closet.
- Maximum distance from cistern is 3000mm.
- Installer will need to fabricate the flush pipe if installed remotely.



ELEMENTi®

10 Year Residential Guarantee*

5 Year Commercial Guarantee*

1 Year Guarantee on Seat, Buttons & Cistern Parts*

Soft Close Seat System

Hyperjet Flushing System

Hand Finished Vitreous China

PARISI

10 Year Residential & Commercial Inwall Cistern Guarantee*

10 Year Residential & Commercial Guarantee (Sway D2 Seat)*

5 Year Residential Push Plate Guarantee*

1 Year Commercial Push Plate Guarantee*

Uno Overheight/Accessible BTW Pan
Twin Raised Accessible Button Set Chrome

Support 90 Degree Grab Rail
Support Adjustable Padded Toilet Back Rest

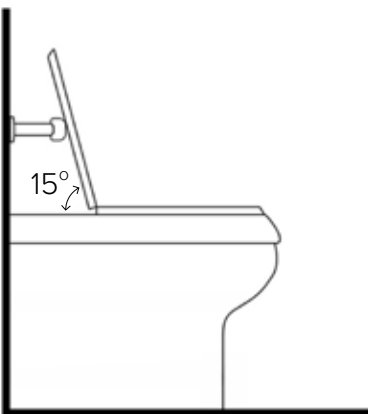

ACCESSIBLE INSTALLATION

Elementi back-to-wall toilet pans can be specified for accessible applications when installed in accordance with NZS 4121:2001. Compliance depends on the full installation.

Where rear support is not provided, a backrest (typically set at 10–15°) may be required. Pan projection and clearances should also be considered.

Pair with backrest 71126.SS or 60888.SS.
See page 31.



URINALS

COTTO

CHLOE TOP INLET URINAL

300(L) X 350 (W) X 690(H)
WELS 5 STAR:
1L AVERAGE PER FLUSH

GLOSS WHITE
VITREOUS CHINA:
C3020710



COTTO

CHLOE BACK INLET URINAL

300(L) X 350 (W) X 690(H)
WELS 5 STAR:
1L AVERAGE PER FLUSH
FOR USE WITH ANY REPUTABLE
BRAND BACK INLET FLUSH VALVE

GLOSS WHITE
VITREOUS CHINA:
C30207B1.0



PARISI

ENVY BACK INLET URINAL

285 (L) X 350 (W) X 695(H)
WELS 6 STAR:
0.8L AVERAGE PER FLUSH
FOR USE WITH ANY REPUTABLE
BRAND BACK INLET FLUSH VALVE

GLOSS WHITE
VITREOUS CHINA
WITH URINE
DETECTION SYSTEM:
PN360/A

GLOSS WHITE
VITREOUS CHINA
WITHOUT URINE
DETECTION SYSTEM:
PN360



URINE DETECTION FLUSHING SYSTEM

The wall hung Envy Urinal with Urine Detection Flushing System uses a solenoid valve to assist with automatic flushing. The flush is activated within 10 seconds after use. If the sensor does not detect any usage for 48 hours, the urinal will automatically flush. Options available with setting.

COTTO

**URINAL
FLUSH VALVE**

CHROME:
CT475SS



COTTO

URINAL DIVIDER

310 X 145 X 610MM
INCLUDES BRACKETS

GLOSS WHITE
VITREOUS CHINA:
C306.10



COTTO

10 Year Residential Guarantee* (Urinal)
5 Year Commercial Guarantee* (Urinal)
5 Year Residential & Commercial Guarantee* (Flush Valve)
CottoCeram Ultra-Clean+
Hand Finished Vitreous China

PARISI

10 Year Residential Guarantee*
Easyclean Antibacterial Protection
Hand Finished Vitreous China



*All guarantees are subject to terms and conditions and available at:
robertson.co.nz/warranties



SENSOR TAPWARE

ELECTRA SENSOR DIGITAL SELF POWERED BASIN MIXER



BLUETOOTH
 MAINS PRESSURE:
 WELS 4 STAR 6 L/MIN
 CHROME:
 92302239



ELECTRA SENSOR DIGITAL SELF POWERED BASIN MIXER EXTRA LARGE



BLUETOOTH
 MAINS PRESSURE:
 WELS 4 STAR 6 L/MIN
 CHROME:
 93302239



NO POWER? NO PROBLEM!

HANSAELECTRA takes intelligence to the next level. The power module generates electricity from the faucet's water usage. No Power supply or battery is required - simple installation and power generation included.

DESIGNED TO MAKE A DIFFERENCE



Unique anti scalding feature

Sensor tracks temperature and shuts off when water exceeds the preset temperature.

New self cleaning valve

Less energy consumption and a self cleaning membrane for extended lifetime.



High end materials

Metal free waterways with new composite.



Tilt aerator to adjust water beam

10° adjustment range in any direction to perfectly match any basin shape.



Advanced PSD Sensor technology

New designed low energy sensor with improved detection area, temperature tracking and extended range of App-based settings.



Power where there is no power

Self powering variant.



10 Year Residential Guarantee*
 5 Year Commercial Guarantee*
 Design Award: Plus X

Tilting Aerator
 Bluetooth Technology
 PSD Sensor

Anti scalding Protection
 Temperature Measurement
 Digital Network Service

Digital Power Module
 Mains Pressure
 Lead Free**

Designed and Engineered in Germany

**Complies to the international standard for Lead Free faucets (0.25% or less).



Electra Basin Mixer
Finish: Chrome



Electra Basin Mixer Extra Large
Finish: Chrome



SENSOR TAPWARE

GOOSENECK CBS SENSOR FAUCET



MAINS PRESSURE:
WELS 6 STAR 4.5 L/MIN
INCLUDES TRANSFORMER
PLUG IN OR
BATTERY POWERED
CHROME:
FH001-26



QUADRATE CBS SENSOR FAUCET



MAINS PRESSURE:
WELS 6 STAR 4.5 L/MIN
INCLUDES TRANSFORMER
PLUG IN OR
BATTERY POWERED
CHROME:
FH004-26



SURGE CBS SENSOR FAUCET



MAINS PRESSURE:
WELS 6 STAR 4.5 L/MIN
INCLUDES TRANSFORMER
PLUG IN OR
BATTERY POWERED
CHROME:
FH101-26



TILT CBS SENSOR FAUCET



MAINS PRESSURE:
WELS 6 STAR 4.5 L/MIN
INCLUDES TRANSFORMER
PLUG IN OR
BATTERY POWERED
CHROME:
FH005-26
NOTE: INDENT ONLY



PATENTED TIME OF FLIGHT CBS SENSOR

Colour Background Suppression (CBS) provides an anti-glare sensor that reduces false detection as experienced with Infra-Red Technology.

MICRO VALVE

EASY INSTALLATION AND MAINTENANCE

The ultra compact micro valve is one piece, making accessibility and maintenance a breeze.

ULTRA COMPACT VANDAL RESISTANT DESIGN

Perfect for applications where space is limited with no exposed moving or separated parts.

ANTI HAMMER

Built in Anti Hammer. No requirement for calibration.

FILTER

Filter supplied mandatory use.

POWER SUPPLY

PLUG IN OR BATTERY POWERED

Choose from either Plug in or battery installation with both options provided, giving you maximum flexibility for installation.

MIXED USE

Certified to use in multiple environments such as those with high temperature or high humidity. Voltage will remain stable regardless of temperature.

AUTO SHUT OFF ENERGY RESERVE

Energy reserved inside to detect main power outage and force closure of water in case of issues.

SURGE PROTECTION

Protection against surge 2KV and burst 4KV.



ELEMENTi[®]

5 Year Residential & Commercial Guarantee*
3 Year Guarantee on Power Supply Pack*
1 Year Guarantee on Sensor, Valve, Battery Box, Parts and Labour*
Patented time of flight CBS sensor
100% Electronic Certified
Lead Free**

Surge Protection
Vandal Resistant Design
Anti-Hammer
Compact Design
Supplied Filter
Easy Installation/Maintenance

Low voltage/low consumption
Plug in or Battery powered
Instant Flow
Low Battery Warning
Waterproof components
Auto Shut Off

**Complies to the international standard for Lead Free faucets (0.25% or less).



Gooseneck CBS Sensor Faucet
Surge CBS Sensor Faucet
Quadrate CBS Sensor Faucet

*All guarantees are subject to terms
and conditions and available at:
robertson.co.nz/warranties



TAPWARE & MIXERS

CONVENIENTLY PRACTICAL

HANSAPOLO is a range of user-friendly, long lasting and versatile faucets that encapsulates our decades of experience. A range of faucets that offer the perfect balance between contemporary and modern design and reliable, smart technology. In all, high quality, sustainable and great value for money –and one of our all time favourite ranges.

POLO BASIN MIXER

35MM CARTRIDGE
MAINS PRESSURE:
WELS 5 STAR 6 L/MIN
CHROME:
514222930037



POLO KITCHEN MIXER

35MM CARTRIDGE
SWIVEL SPOUT
140 DEGREE SPOUT RANGE
MAINS PRESSURE:
WELS 4 STAR 7.5 L/MIN
CHROME:
514822930037



POLO SHOWER MIXER TRIMSET

40MM CARTRIDGE
REQUIRES 50510100SP
CHROME:
50629093



ALSO REQUIRES VARIO BUILT IN PART/VALVE FOR SHOWER MIXER

40MM CARTRIDGE
MAINS PRESSURE
CODE:
50510100SP



10 Year Residential Guarantee*
5 Year Commercial Guarantee*
Mains Pressure

Mains Pressure
Swivel Spout (Kitchen Mixer)
Rapid Installation System

Limitation Option for Maximum Temperature and Flow-rate
Adjustable Hot Water Stop (included, retrofittable)
Designed and Engineered in Germany



Polo Basin Mixer
Finish: Chrome



Polo Kitchen Mixer
Finish: Chrome

*All guarantees are subject to terms
and conditions and available at:
robertson.co.nz/warranties



TAPWARE & MIXERS

MEDIPRO BASIN MIXER



48MM CARTRIDGE
 MAINS PRESSURE:
 WELS 1 STAR 12 L/MIN
 CHROME:
01622196



MEDIPRO 2TH WALL MOUNTED BASIN MIXER



161MM SPOUT
 48MM CARTRIDGE
 SWIVEL SPOUT
 MAINS PRESSURE:
 WELS 1 STAR 12 L/MIN
 CHROME:
02552206



MEDIPRO 2TH WALL MOUNTED BASIN MIXER



226MM SPOUT
 48MM CARTRIDGE
 SWIVEL SPOUT
 MAINS PRESSURE:
 WELS 1 STAR 12 L/MIN
 CHROME:
02572206



OPTIONAL EXTRA:

MEDIPRO LONG LEVER HANDLE 149MM



COMPATIBLE
 WITH 01622196, 02552206 AND 02572206
 CHROME:
02440005



IMPROVE HYGIENE

MEDIPRO products have been developed specifically for hospitals and other demanding healthcare settings. Designed to fit seamlessly into a complex and busy environment while meeting every ergonomic need and hygiene guideline.



Minimal risk of injury

Rounded contours and an optional hot water stop minimise the risk of any injury.

Easy to clean

A smooth surface allows for easy cleaning.

Safe water quality

The HANSAPROTEC system means all faucets are made with material according to the new low lead standards. In addition, all waterways are nickel-free.



10 Year Residential Guarantee*
 5 Year Commercial Guarantee*
 Laminar Stream
 Laminar Stream Aerator

Triple Seal Cover Plate
 Scalding Safety Lock
 Reduced Heat of Housing
 Rapid Installation System

Cover Plate Triple Sealed
 Thermal Disinfection
 Max. 80°
 Mains Pressure

Eccentric Coupling(s)
 Limitation Option for Maximum Temperature and Flow-rate
 Designed and Engineered in Germany
 Lead Free**

**Complies to the international standard for Lead Free faucets (0.25% or less).



MEDIPRO 2TH Wall Mounted Basin Mixer
Finish: Chrome

*All guarantees are subject to terms
and conditions and available at:
robertson.co.nz/warranties



TAPWARE & MIXERS

SAVON BASIN MIXER

INCLUDES BASE RING
35MM CARTRIDGE
MAINS PRESSURE:
WELS 5 STAR 5.5 L/MIN
CHROME:
43151.02



SAVON WALLMOUNTED BASIN/BATH MIXER

NEW

35MM CARTRIDGE
MAINS PRESSURE:
BASIN: WELS 5 STAR 5.5 L/MIN
BATH: WELS 0 STAR 20 L/MIN
CHROME:
43156.02

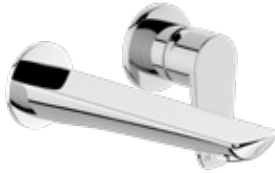

SAVON SHOWER MIXER

NEW

Ø65
MAINS PRESSURE
35MM CARTRIDGE
CHROME:
43770.02



OPTIONAL EXTRA:

SAVON LAB LEVER HANDLE

NEW

168MM
COMPATIBLE WITH SAVON BASIN MIXER (43151.02),
WALL MOUNTED BASIN MIXER (43156.02)
& SHOWER MIXER (43770.02)
CHROME:
EQ-6009424-01-RS

Does comply
with NZS 4121:2001



SAVON EXTENDED HANDLE

NEW

116MM
COMPATIBLE WITH SAVON BASIN MIXER (43151.02),
WALL MOUNTED BASIN MIXER (43156.02)
& SHOWER MIXER (43770.02)
CHROME:
EQ-6009324-01-RS



SHOWERS

SPLASH ROUND 1 FUNCTION SHOWER ROSE

Ø100MM / AQUA AIR
LOW/UNEQUAL PRESSURE
3 STAR 8 L/MIN
MAINS PRESSURE:
3 STAR 8 L/MIN



CHROME:
40208.02

SPLASH SQUARE 1 FUNCTION SHOWER ROSE

100MM / AQUA AIR
LOW/UNEQUAL PRESSURE:
3 STAR 8 L/MIN
MAINS PRESSURE:
3 STAR 8 L/MIN



CHROME:
40211.02

SPLASH ROUND 2 FUNCTION SHOWER ROSE

Ø100MM / AQUA AIR
MAINS PRESSURE:
3 STAR 8 L/MIN



CHROME:
40212.02

BRUSHED
NICKEL:
40212.04



BLACK:
40212.13



ANTI VANDAL SHOWER HEAD



MAINS PRESSURE:
WELS 3 STAR 8 L/MIN
CHROME:
40207.02



ANTI VANDAL

An anti-vandal shower head is specifically designed to reduce damage and tampering in public or high traffic restrooms. Constructed from durable materials and a heavy duty mounting plate this shower head is built to withstand rough handling and vandalism attempts.

Featuring a streamlined, minimalist design to minimise the potential for misuse and equipped with tamper resistant fittings along with a flow restrictor to maintain water conservation.

As added flexibility our anti-vandal showerhead has the ability to be installed in either rear water inlet or exposed water inlet situations by simply removing the blanking plug attaching a 15mm pipe connector and hose.

By incorporating these protective features, antivandal shower heads help ensure that public facilities remain functional and hygienic, reducing maintenance costs and extending the lifespan of the equipment.

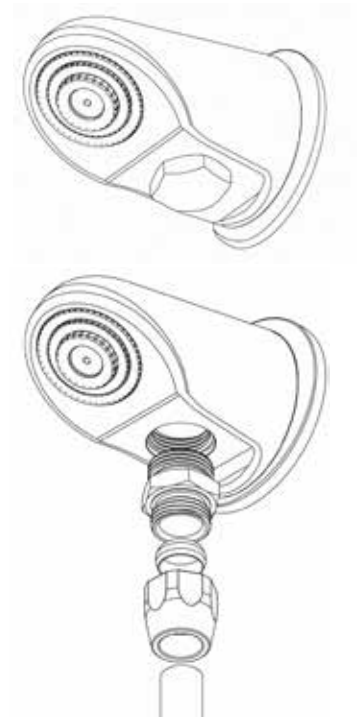

SHOWERS

HANSAVIVA

Designed for aged care and accessible bathrooms. Ergonomic controls, intuitive operation and water-wise performance make HANSAVIVA suited to environments where residents need confidence and staff need consistency, every day.

HANSA BASICJET

A versatile, hard-wearing choice. A 3-spray hand shower built to pair with any modern fitting. Practical to specify and well suited to hotels, multiunit residential and commercial fit-outs.

HANSA

VIVA SLIDE SHOWER

C/W 3 FUNCTION HAND PIECE

50 - 500 KPA

RAIL LENGTH: 971MM

INCLUDES SOAP DISH

MAINS PRESSURE:

WELS 2 STAR RATED 12L/MIN

CHROME:

44150330

ELEMENTI

UNIVERSAL WALL ELBOW FEMALE

FEMALE

CHROME:

40305.02



HANSA

VIVA 3 FUNCTION HAND PIECE

MAINS PRESSURE:

WELS 2 STAR RATED 12L/MIN

CHROME:

44330300



HANSA

BASICJET ECO SLIDE SHOWER

C/W 3 FUNCTION HAND PIECE

50 - 500 KPA

RAIL LENGTH: 764MM

INCLUDES SOAP DISH

MAINS PRESSURE:

WELS 3 STAR RATED 9LM/MIN

CHROME:

44780133

ELEMENTI

UNIVERSAL WALL ELBOW FEMALE

FEMALE

CHROME:

40305.02



HANSA

BASICJET ECO FLOW 1 FUNCTION HAND PIECE

50 - 500 KPA

MAINS PRESSURE:

WELS 3 STAR RATED 9L/MIN

CHROME:

44610300



HANSA

BASICJET ECO FLOW 3 FUNCTION HAND PIECE

50 - 500 KPA

MAINS PRESSURE:

WELS 3 STAR RATED 9L/MIN

CHROME:

44630300



5 Year Residential Guarantee*
1 Year Commercial Guarantee*

Mains Pressure
Multi Function

Easy Clean Anti Limescale Technology
Designed and Engineered in Germany

Twist Guard Hose

ELEMENTI
**SPLASH LUX
SLIDE SHOWER**

C/W 3 FUNCTION Ø30MM HAND PIECE
RAIL LENGTH: 900MM
ADJUSTABLE FIXATION
MAINS PRESSURE:
2 STAR 12 L/MIN



CHROME:
40370.02

↗
Bottom rear
water inlet



BRUSHED
NICKEL:
40370.04

GUN
METAL:
40370.29

BLACK
40370.13

BRUSHED
BRASS:
40370.07



ELEMENTI
**SPLASH LUX
COLUMN SHOWER**

C/W 3 FUNCTION Ø30MM HAND PIECE
Ø250MM ROUND SHOWERHEAD
3 SHOWERING EXPERIENCES
EXTRA LONG 445MM REACH
MAINS PRESSURE:
2 STAR 12 L/MIN



CHROME:
40371.02

↗
Bottom rear
water inlet



BRUSHED
NICKEL:
40371.04

GUN
METAL:
40371.29

BLACK:
40371.13

BRUSHED
BRASS:
40371.07



ELEMENTI®

5 Year Guarantee*
2 Year Coloured Finish Guarantee*
1 Year Guarantee on Shower Parts/Hoses*

Easy Clean Nozzles
Easy Clean Smooth Hose
Easy Glide Slider

Mains Pressure
Multi Function
Check Valve

*All guarantees are subject to terms
and conditions and available at:
robertson.co.nz/warranties



CENTRAL BRASS®

A LEGACY OF EXCELLENCE TRUSTED BY COMMERCIAL BUILDERS FOR OVER 120 YEARS

Products from Central Brass have been the go-to resource for contractors, builders and plumbers for over 100 years. Their goal is to make choosing kitchen mixers and fixtures the easiest part of the project. Enjoy the peace of mind that comes from knowing they're a company with decades of experience with a commitment to quality. Rest assured when you choose Central Brass, you're choosing something that is made to last.

Commercial kitchen mixers are indispensable in professional culinary environments, offering efficiency and versatility in food preparation and cleaning up. These robust mixers are designed to withstand the rigours of everyday use. Providing reliable water flow for various kitchen tasks, from rinsing wastes to filling pots for cooking. The essential specialised pre rinse spray is tailored to tackle the unique challenges of maintaining hygiene in a busy kitchen. These powerful sprays are designed to remove grease, grime, and food residues, not only do they create a more hygienic environment but also reduce the risk of cross-contamination and upholding stringent food safety standards.



PRE-RINSE MIXER

Extra spraying power and the convenience of flexible design are the primary advantages of a pre-rinse mixer. These are great for rinsing dishes that have just arrived in the kitchen, or ones that have been splattered with food and unfortunately set to the side.

A pre-rinse mixer boasts strong jets of water able to power-off heavy amounts of food. Its unusually tall and incredibly flexible hose is ideal for reaching around and under large, awkwardly shaped dishes to get into every corner, nook and cranny.

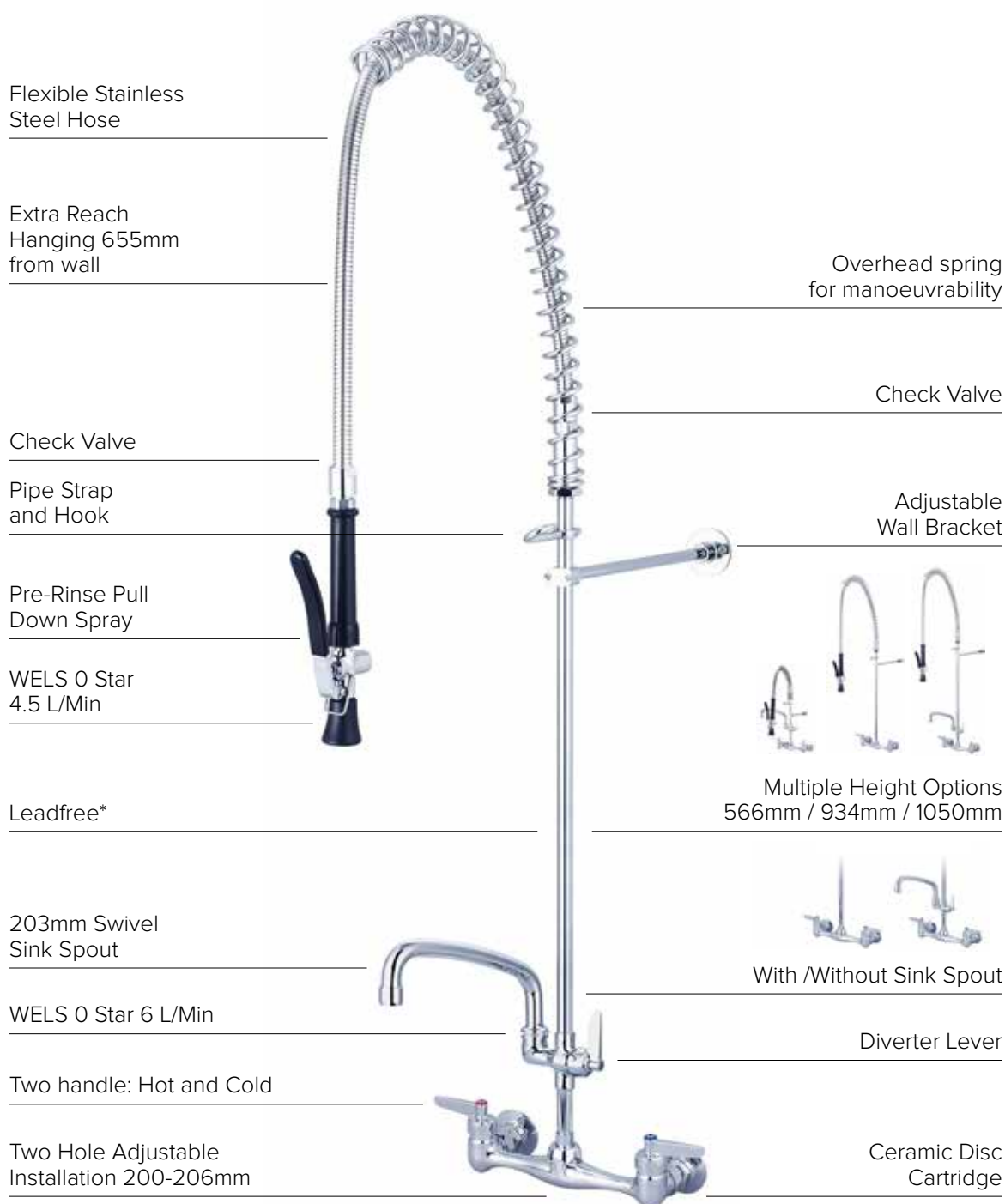

NEW COMMERCIAL PRE-RINSE KITCHEN MIXERS

CENTRAL BRASS
WALL MOUNT PRE-RINSE COMMERCIAL KITCHEN MIXER WITH SINK SPOUT

PRE-RINSE
 WELS 0 STAR 4.5 L/MIN SINK
 SPOUT WELS 0 STAR 6 L/MIN
 CHROME:
44681.02

OPTIONAL EXTRA:
CONCENTRIC FITTINGS FOR COMMERCIAL FAUCETS (PAIR)

CODE:
44690.02



Chrome Plated Brass Handle with PVC coating for heat resistance

Integrated Stainless Steel Clip to Hold Handle Open

Serviceable Valve Components, Brass Stem and Stainless Steel Spring

One piece Stainless Steel Nozzle

Rubber Nozzle Bumper

CENTRAL BRASS
WALL MOUNT EXTENDED HEIGHT PRE-RINSE COMMERCIAL KITCHEN MIXER WITH SINK SPOUT

PRE-RINSE WELS 5 STAR 5 L/MIN
 SINK SPOUT WELS 0 STAR 6 L/MIN
 CHROME:
44683.02

OPTIONAL EXTRA:
CONCENTRIC FITTINGS FOR COMMERCIAL FAUCETS (PAIR)

CODE:
44690.02



CENTRAL BRASS
WALL MOUNT EXTENDED HEIGHT PRE-RINSE COMMERCIAL KITCHEN MIXER

PRE-RINSE WELS 5 STAR 5 L/MIN
 CHROME:
44685.02

OPTIONAL EXTRA:
CONCENTRIC FITTINGS FOR COMMERCIAL FAUCETS (PAIR)

CODE:
44690.02



CENTRAL BRASS
DECK MOUNTED EXTENDED HEIGHT PRE-RINSE COMMERCIAL KITCHEN MIXER WITH SINK SPOUT

PRE-RINSE WELS 5 STAR 5 L/MIN
 SINK SPOUT WELS 4 STAR 7 L/MIN
 CHROME:
44695.02



CENTRAL BRASS®

5 Year Residential & Commercial Warranty*
 Pre-Rinse Pull Down Spray
 Ceramic Disc Cartridge
 Adjustable Wall bracket for additional support
 Two handle: Hot & Cold

Divertor lever: Switch between overhead pre-rinse spray and sink spout
 Pipe Strap and Hook Assembly
 1/2" Female BSP Pipe Thread
 Pail/Bucket Hook (Applies to 44687.02)

Overhead spring for manoeuvrability
 Swivel Spout
 Two hole adjustable installation
 Vacuum Breaker

Central Brass products are for export only and do not comply with G12/AS1 3rd edition Amendment 14

NEW COMMERCIAL POT FILLERS & SERVICE SINK MIXERS

CENTRAL BRASS
2TH WALL MOUNT EXTENDED POT FILLER

SWIVEL SPOUT
 HOT/COLD WATER
 WELS 4 STAR 7 L/MIN
 CHROME:
44691.02



OPTIONAL EXTRA:
**CONCENTRIC FITTINGS
 FOR COMMERCIAL
 FAUCETS (PAIR)**

CODE:
44690.02



CENTRAL BRASS
1TH WALL MOUNT EXTENDED POT FILLER

SWIVEL SPOUT
 FOR COLD WATER
 WELS 4 STAR 7 L/MIN
 CHROME:
44693.02



OPTIONAL EXTRA:

SWIVEL SPOUT

Don't get stuck with a stationary spout if you have multicompartmental sinks or large pots or buckets that need filling. Swivel spouts can move from left to right and work brilliantly for switching from a rinse sink to a washing-up sink. They also work great for larger items that need the space for lifting, where a stationary faucet would just get in the way.

CENTRAL BRASS
**152MM SWIVEL TUBE SPOUT FOR
 COMMERCIAL SINK SPOUT**

WELS 0 STAR 6 L/MIN
 CHROME:
44672.00



CENTRAL BRASS
**305MM SWIVEL TUBE SPOUT FOR
 COMMERCIAL SINK SPOUT**

WELS 0 STAR 6 L/MIN
 CHROME:
44674.00



CENTRAL BRASS®

5 Year Residential & Commercial Warranty*
 Ceramic Disc Cartridge
 Adjustable Wall bracket for additional support
 Two handle: Hot & Cold

Vacuum Break
 Swivel Spout
 (Applies to 44690.02 & 44693.02)
 Two hole adjustable installation

Hose Thread (Applies to 44687.02)
 Pail/Bucket Hook (Applies to 44687.02)

Central Brass products are for export only and do not comply with G12/AS1 3rd edition Amendment 14

*All guarantees are subject to terms and conditions and available at:
robertson.co.nz/warranties



ACCESSIBLE RAILS

SUPPORT STRAIGHT HAND RAILS

DIAMOND KNURL

300MM
BRUSHED STAINLESS STEEL:
71102.SS



600MM
BRUSHED STAINLESS STEEL:
71104.SS



SUPPORT 45° SAFETY RAIL

305(L) X 305(H)
DIAMOND KNURL
BRUSHED STAINLESS STEEL:
71114.SS



SUPPORT 90° SAFETY RAIL

750(L) X 750(H)
DIAMOND KNURL
BRUSHED STAINLESS STEEL:
71110.SS



HYGIENIC SURE-GRIP

The Elementi design team has developed a unique range of safety rails with a sleek non-slip hygienic surface. These are widely used in the healthcare sector, conscious of the need to maintain cleanliness.

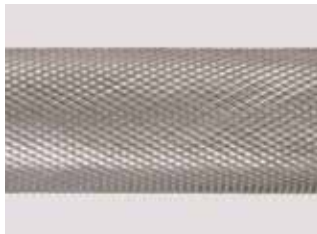

DIAMOND KNURL

Diamond anti-slip knurling comes with all Support rails

DURABLE Ø32MM RAILS

Unlike alternatives, both the Assist and Support collections come with a Ø32mm thickness of rail aiding durability and longevity.

Complies to NZS 4121:2001.



HEAVY DUTY FIXINGS

Assist and Support hand rails feature heavy duty fixings for added extra strength and stability.

Complies to NZS 4121:2001.

LEFT OR RIGHT HAND?

Both the 90° and 45° safety rail can be used in either a left or right hand application.

Complies to NZS 4121:2001.



ELEMENTi®

Support:

10 Year Residential & Commercial Warranty*
Grade 304 Stainless Steel
No Plating or Brushing Process
Heavy Duty Fixings

Highly Resistant to Spotting
Manufactured to ISO9001:2015 Quality Management
Durable & Easy to Maintain
Multiple Fixing Points with full cover flange

ACCESSIBLE SHOWER RAILS

SUPPORT STRAIGHT SLIDE SHOWER SAFETY RAIL

WITH SLIDER.
REQUIRES SHOWER HOSE,
ELBOW & HANDPIECE
DIAMOND KNURL
STRAIGHT
900MM
BRUSHED STAINLESS STEEL:
71116.SS



SUPPORT T SHAPE SLIDE SHOWER SAFETY RAIL

WITH SLIDER.
REQUIRES SHOWER HOSE,
ELBOW & HANDPIECE
DIAMOND KNURL
T SHAPE
900 X 1063MM
BRUSHED STAINLESS STEEL:
71118.SS



EASY FIX

Easily detach the rail from the fixings to allow convenient access to the slider.



EXTRA SUPPORT

32mm Vertical rail for additional safety and support.

Refer to robertson.co.nz to select hose and spray options.



OPTIONAL EXTRA SUPPORT SHOWER RAIL BASKET

FOR 32MM RAILS
STAINLESS STEEL:
71128.SS



SUPPORT ADJUSTABLE PADDED TOILET BACK REST

BRUSHED STAINLESS STEEL:
71126.SS



ADJUSTABLE

The Support Padded Toilet Back Rest includes an innovative adjustment mechanism providing various lengths (220-300mm) to allow for different sized cisterns and toilets or to simply adjust the leaning angle.

PADDED REST

Constructed from robust stainless steel tube for strength and durability, these heavy duty back rests have a padded cushion for the seat to lean against.

ASSIST PADDED TOILET LID SUPPORT RAIL

BRUSHED STAINLESS STEEL:
60888.SS



CUSTOMISABLE

The Assist Padded Toilet Lid Support Rail is fully customisable, and can be made for specification upon request. Contact your local representative.



SHOWER SEATS

SUPPORT FOLDING SLATTED SHOWER SEAT

800MM
BRUSHED STAINLESS STEEL/WHITE:
71120.SS



WEIGHT TESTED COMFORT AND STABILITY

A seat in the shower provides essential support and safety for individuals with restricted movement or those who are unstable on their feet, allowing them to maintain independence and comfort while bathing.

The Support Shower Seat is also weight tested to 200kg to ensure peace of mind.



ASSIST FOLDING SAFETY RAIL

720MM
SURE-GRIP KNURL

BRUSHED STAINLESS STEEL:
60884.SS

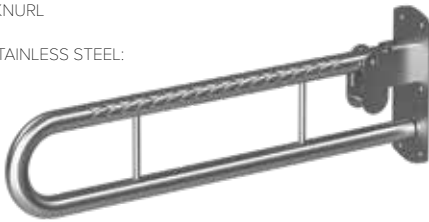

720MM
C/W TOILET ROLL HOLDER
SURE-GRIP KNURL

BRUSHED STAINLESS STEEL:
60886.SS



SURE-GRIP KNURL

Unique sure-grip anti-slip knurling comes with all Assist rails

RIGID SUPPORT

The Assist Folding Safety Rail includes the anti-slip SureGrip knurling with an option that incorporates a toilet roll holder.

A locking feature is also available if required. This means the rail locks into place when folded into the upright position, offering the user rigid support whilst standing. Constructed from Ø32 stainless steel tube as standard with Ø25 available on request.

ELEMENTi®

Assist:

10 Year Residential & Commercial Warranty*
Grade 304 Stainless Steel
Heavy Duty Fixings
Made in New Zealand
Multiple Fixing Points

Support:

10 Year Residential & Commercial Warranty*
Grade 304 Stainless Steel
No Plating or Brushing Process
Heavy Duty Fixings

Highly Resistant to Spotting
Manufactured to ISO9001:2015 Quality Management
Durable & Easy to Maintain
Multiple Fixing Points

SHOWER TRACKS

ASSIST STRAIGHT SHOWER TRACK

1200MM STRAIGHT
WITH HANGER ASSEMBLY KIT
SILVER:
60890.00



ASSIST STRAIGHT SHOWER CURTAIN

FOR 1200MM STRAIGHT
1400 X 2000MM - 9 EYELETS
WHITE:
60894.00

ASSIST ROUND SHOWER TRACK

1200 X 1200MM ROUND
WITH HANGER ASSEMBLY KIT
SILVER:
60892.00



ASSIST ROUND SHOWER CURTAIN

FOR 1200 X 1200MM ROUND
2600 X 2000MM - 16 EYELETS
WHITE:
60896.00



SPECIFICALLY DESIGNED

The Assist shower tracks have been specifically designed for use in accessible bathrooms in resthomes, hospitals, retirement villages and residential homes. Manufactured in NZ from premium powder coated aluminium, these superior tracks showcase a sleek, minimalistic profile.

The tracks are provided as a kit-set complete with:

- Required screws and wall fittings
- Nylon glides
- Heavy duty stainless steel curtain hooks
- Adjustable length ceiling hanger/s as required
- 2 different lengths available depending on ceiling height and track installation height

CUSTOM SIZES AVAILABLE

Being manufactured here in New Zealand, it's no problem at all to do custom sizes. Contact us for more information and we will work with you to find a solution.



ACCESSIBLE BATHROOM

Recommended Products

TOILET

ELEMENTI
**UNO ACCESSIBLE/OVERHEIGHT
 BTW CC TOILET SUITE**

WITH ELEMENTI
 BLUE ACCESSIBLE SEAT:
14859.10



TAPWARE

ELEMENTI
SAVON BASIN MIXER

CHROME:
43151.02



ELEMENTI
SAVON LAB LEVER HANDLE

CHROME:
EQ-6009424-01-RS

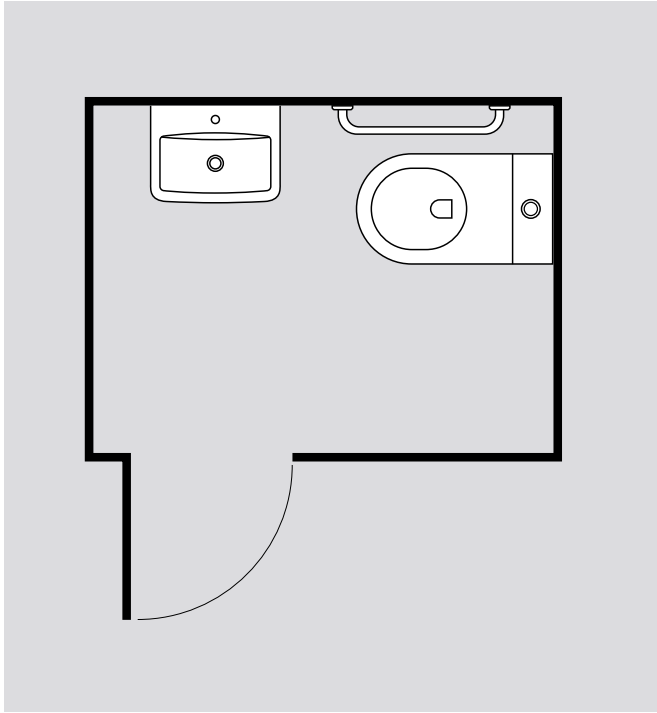

BASIN, WASTE & TRAP

COTTO
SERVE S WALL BASIN
 500(L) X 375(W) X 175(H)
 GLOSS WHITE:
C00580



ELEMENTI
**UNIVERSAL
 BASIN CLICKER
 WASTE 32MM**

CHROME:
79230.02



COTTO
SEMI PEDESTAL
 GLOSS WHITE:
C4243



ELEMENTI
**32MM INSULATED
 BOTTLE TRAP**

CHROME:
79144.02



ACCESSORIES

ELEMENTI
SUPPORT 90° SAFETY RAIL
 750(L) X 750(H)
 BRUSHED STAINLESS STEEL:
71110.SS



ELEMENTI
SUPPORT STRAIGHT HAND RAILS
 BRUSHED STAINLESS STEEL
 300MM
71102.SS



600MM
71104.SS



OPTIONAL EXTRAS

ELEMENTI
ASSIST FOLDING SAFETY RAIL
 720MM
 SURE-GRIP KNURL
 BRUSHED STAINLESS STEEL:
60884.SS

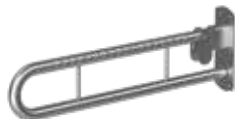

ELEMENTI
RAISED PUSH BUTTON



BLUE:
B5503



WHITE:
B5503W

All diagrams are indicative of bathroom regulations. Please check NZS 4121:2001 before specifying.

Recommended Products

ACCESSIBLE BATHROOM + SHOWER

TOILET

ELEMENTI
**UNO ACCESSIBLE/OVERHEIGHT
 BTW CC TOILET SUITE**
 WITH ELEMENTI
 BLUE ACCESSIBLE SEAT:
14859.10



TAPWARE

ELEMENTI
SAVON BASIN MIXER
 CHROME:
43151.02



ELEMENTI
SAVON LAB LEVER HANDLE
 CHROME:
EQ-6009424-01-RS

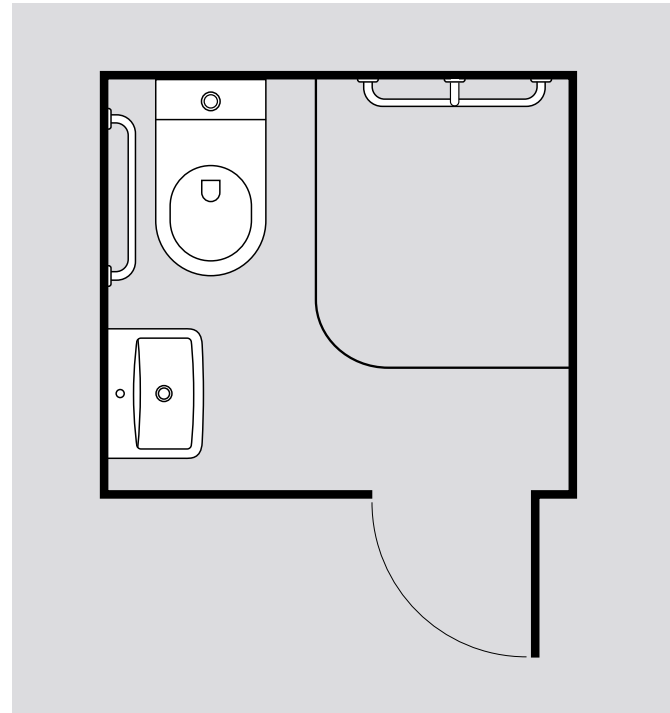

BASIN, WASTE & TRAP

COTTO
SERVE S WALL BASIN
 500(L) X 375(W) X 175(H)
 GLOSS WHITE:
C00580



ELEMENTI
**UNIVERSAL
 BASIN CLICKER
 WASTE 32MM**
 CHROME:
79230.02



COTTO
SEMI PEDESTAL
 GLOSS WHITE:
C4243



ELEMENTI
**32MM INSULATED
 BOTTLE TRAP**
 CHROME:
79144.02



ACCESSORIES

ELEMENTI
SUPPORT 90° SAFETY RAIL
 750(L) X 750(H)
 BRUSHED
 STAINLESS STEEL:
71110.SS



ELEMENTI
SUPPORT STRAIGHT HAND RAILS
 BRUSHED STAINLESS STEEL
 300MM:
71102.SS
 600MM:
71104.SS



OPTIONAL EXTRAS

ELEMENTI
RAISED PUSH BUTTON



BLUE:
B5503



WHITE:
B5503W

SHOWER

ELEMENTI
**SUPPORT T SHAPE SLIDE
 SHOWER SAFETY RAIL**
 WITH SLIDER.
 900 X 1063MM
 BRUSHED
 STAINLESS STEEL:
71118.SS



ELEMENTI
**SUPPORT FOLDING
 SLATTED SHOWER SEAT**
 800MM
 BRUSHED STAINLESS STEEL/WHITE:
71120.SS



HANSA
**BASICJET
 1 FUNCTION
 HAND PIECE**
 MAINS PRESSURE:
 WELS NOT STAR
 RATED 16L/MIN
 CHROME:
44610300



ELEMENTI
**SMOOTH SHOWER
 HOSE 1.5M**
 CHROME:
40300.02



ELEMENTI
**UNIVERSAL
 WALL ELBOW**
 FEMALE
 CHROME:
40305.02



ELEMENTI
SAVON SHOWER MIXER
 Ø65 / MAINS PRESSURE
 35MM CARTRIDGE
 CHROME:
43770.02



ELEMENTI
**ASSIST ROUND
 SHOWER TRACK**
 1200 X 1200MM ROUND
 WITH HANGER ASSEMBLY KIT
 SILVER:
60892.00



ELEMENTI
**ASSIST ROUND
 SHOWER CURTAIN**
 FOR 1200 X 1200MM ROUND
 2600 X 2000MM - 16 EYELETS
 WHITE:
60896.00

All diagrams are indicative of bathroom regulations. Please check NZS 4121:2001 before specifying.

*All guarantees are subject to terms and conditions and available at: robertson.co.nz/warranties



COMMERCIAL OFFICE BATHROOM

Recommended Products

TOILET & URINAL

ELEMENTI

**UNO OVERHEIGHT
BTW CC TOILET SUITE**WITH PARISI
SWAY D2 SEAT:
14763.10

PARISI

ENVY BACK INLET URINALGLOSS WHITE
VITREOUS CHINA
WITH URINE
DETECTION SYSTEM:
PN360/A

COTTO

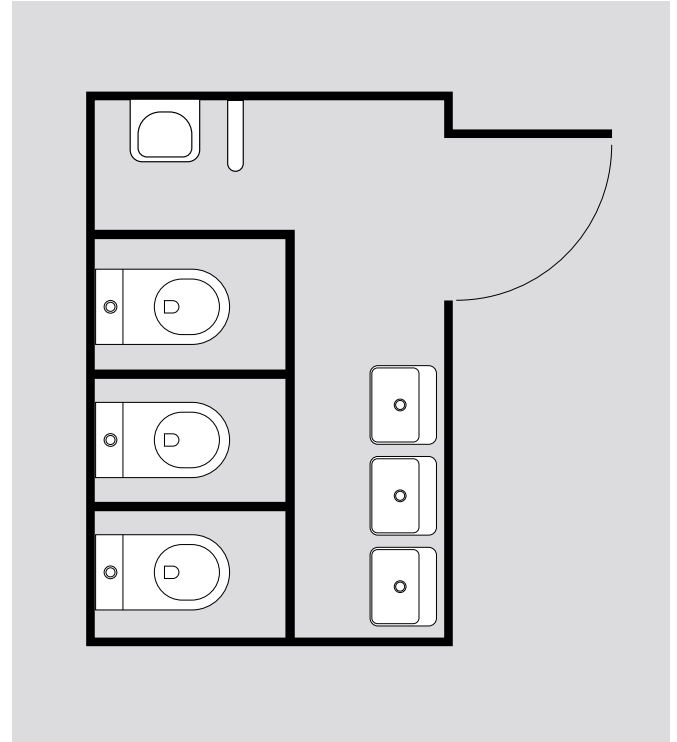
URINAL DIVIDER310 X 145 X 610MM
GLOSS WHITE
VITREOUS CHINA:
C306.10

BASIN, TAPWARE, WASTE & TRAP

PARISI

LINFA 400 WALL BASIN400(L) X 380(W) X 120(H)
1TH / WITH OVERFLOW
VITREOUS CHINA
GLOSS WHITE:
PMP7701S

HANSA

**GOOSENECK
CBS SENSOR FAUCET**CHROME:
FH001-26

ELEMENTI

**UNIVERSAL
BASIN CLICKER
WASTE 32MM**CHROME:
79230.02

ELEMENTI

**32MM INSULATED
BOTTLE TRAP**CHROME:
79144.02

robertson®

BATHWARE

— SINCE 1987 —

25 Vestey Drive
Mt Wellington, Auckland 1060

PO Box 14695, Panmure
Auckland 1741, New Zealand

Ph: +64 9 573 0490
Ph: 0800 433 257
Email: sales@robertson.co.nz

robertson.co.nz



You can view and purchase our products nationwide from our supporting bathroom suppliers. To find your nearest location visit robertson.co.nz and click on the 'where to buy' link at the top of the page. Alternatively you can view products at our Robertson Bathware Showrooms at the locations below.

SHOWROOMS

A

AUCKLAND

ROBERTSON

25 Vestey Drive, Mt Wellington
Ph: (09) 573 0490

Open Monday to Friday 8am - 5pm
Saturday 9am - 2pm
Closed Sunday and public holidays

C

CHRISTCHURCH

HOME IDEAS

37 Mandeville Street Riccarton
Ph: (03) 348 2863

Open Monday to Friday 9am - 4pm
Saturday 10am - 2pm Sunday 10am - 2pm

robertson design.ideas™

ROBERTSON DESIGN IDEAS

Email: designideas@robertson.co.nz

ROBERTSONDESIGNIDEAS.CO.NZ



robertson® trade

ROBERTSON TRADE PARTS & SERVICE CENTRE

4-6 Westfield Place
Mt Wellington, Auckland 1060
Email: trade@robertson.co.nz

ROBERTSONTRADE.CO.NZ



ROBERTSON OUTLET STORE

25 Vestey Drive
Mt Wellington, Auckland 1060
Email: outlet@robertson.co.nz
By appointment only

www.trademe.co.nz/stores/robertson-bathware-outlet-store